



Harmony A1

Multi-Room Auracast Speaker System



Interactive User Guide

Version 2.3



First Time Setup

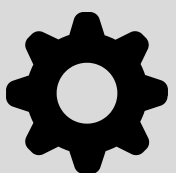

Keep Speakers Always On

< Back



Main Menu

1. Before You Start
2. Connect to Audio Source
3. Listen From Speakers
4. Placement Tips
5. Add Speakers (Optional)
6. Advanced Setup
 - Keep Speakers Always On
 - Broadcast Name & Password
 - Group Settings
 - Extend Range
7. Use as Bluetooth Speaker
8. Firmware Update
9. Troubleshooting
10. Support & Feedback

Next

1. Before You Start

Plug in → Power on → Audio plays automatically

Important to know

- Speakers connect automatically (Auracast)
- Works with Auracast speakers only
- Up to 330 ft (line of sight)
- Signal reduced by walls & people
- Best for background audio, not for loud parties

[Next](#)

[Rate This Guide →](#)

2. Connect to Audio Source

- 1 Connect transmitter to power and switch to ON.
- 2 Choose a connection method:



AUX (3.5mm) >



Bluetooth >

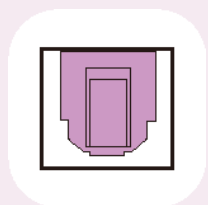

Optical >

Connect Using AUX

- 1 Press  to switch to AUX input
→ **AUX** LED blinks **red**.
- 2 Plug the AUX cable.

Example: Mixer

a. via
"PHONES" jack

b. via "MONITOR OUT"/
"STEREO OUT" JACKS

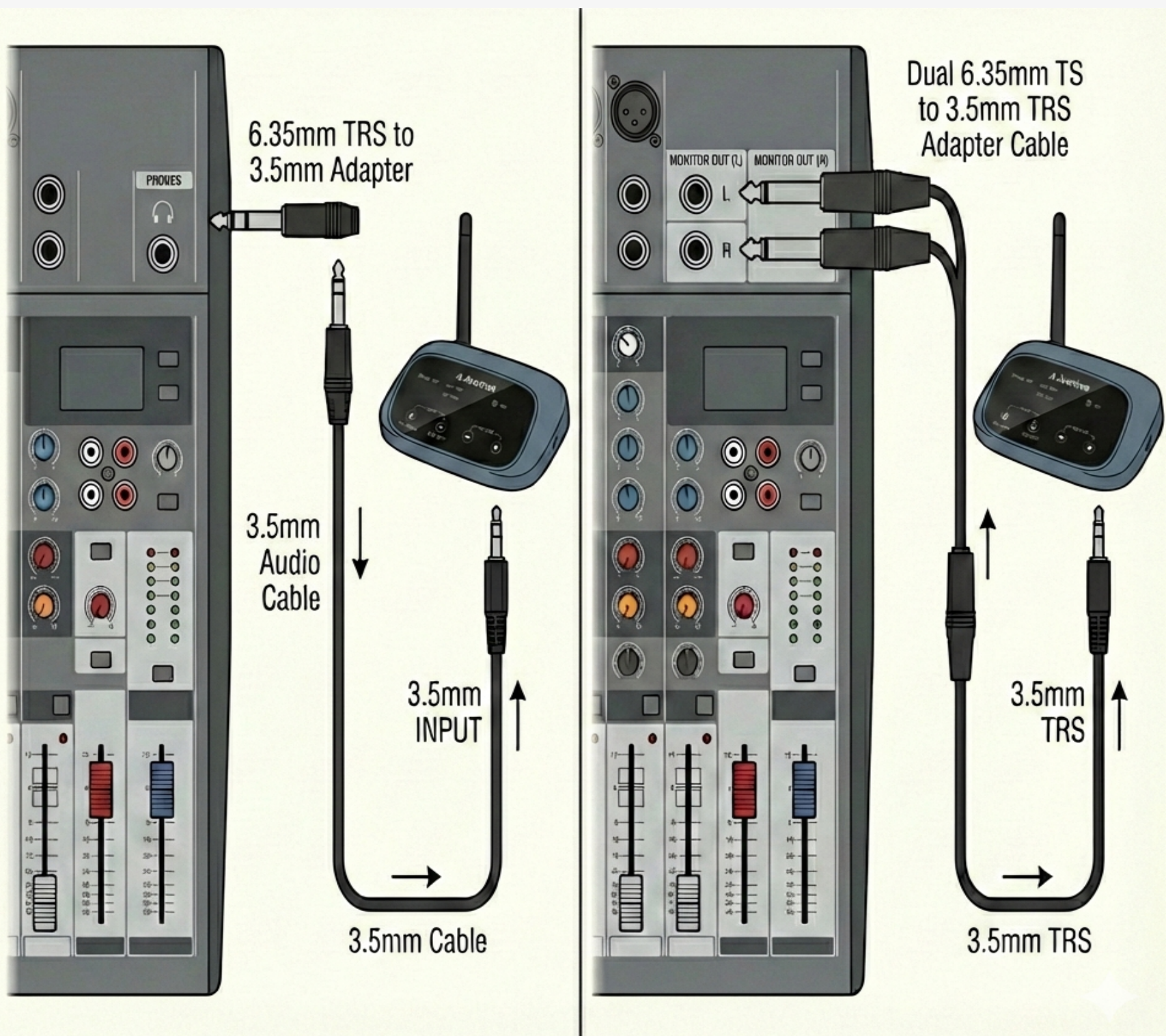

 *Audio is playing from mixer.*

Next

[Rate This Guide →](#)

Connect Using Bluetooth

◆ Keep phone close to transmitter

- 1 Press  → LED blinks red & blue.
- 2 Pair with your device.
- 3 Start playing audio.



! Better Experience

- Use wired audio input for best stability
- Bluetooth range: **10-15 m (30-50 ft)**

Next

[Rate This Guide →](#)

Connect Using Optical

- 1 Press  to switch to OPT input
→ **OPT** LED blinks **red**.
- 2 Plug Optical cable into the transmitter and source device.
- 3 For **Optical** connection users

1 Audio Output

 **Optical**

2 Digital Audio Output

 **PCM (Required)**

If set to **PCM**, you're all set.



*Not sure how to **set PCM**?*

Check [brand-by-brand TV guide](#) ↗

Next

[Rate This Guide](#) →

3. Listen From Speakers

Turn on speakers → Auto-join.

✅ LED **MODE** turns **solid orange**.

All speakers will play the **same** audio.



i LED not orange? Double-press **MODE**.

Next

[Rate This Guide →](#)

4. Placement Tips

1 Transmitter

Place in the center

- Clear line of sight
- Up to 330 ft

2 Phone

⚠ Keep next to transmitter

✘ Do not keep in pocket



Next

[Rate This Guide →](#)

5. Add Speakers (Optional)

Add more Auracast speakers to expand your system.

Avantree speakers & receiver:

- Auto-connect when powered on



[A1 Solo](#)



[A2 Solo](#)



[Lite 1 Solo](#)



[AuraLink](#)

Others brands:

- Use phone app to join Auracast
- Auto-connect not guaranteed

Next

[Rate This Guide →](#)

6. Advanced Setup

6.1 Keep Speakers Always On

Default Behavior

- Auto power off after 60 mins with no audio
- Applies even when a broadcast is joined

After DFU Update

- Speaker **stays ON while plugged in**
- No auto power off without audio

 [Update firmware to keep it ON](#) ↗

Next

[Rate This Guide](#) →

6.2 Broadcast Name & Password

Set a clear broadcast name so users can easily find the correct channel.

Typical use cases:

- Multiple audio channels (e.g. different languages)
- Multiple rooms or programs

Optional:

Add a password if access control is needed.

[Set up on transmitter via DFU](#) ↗

Next

[Rate This Guide](#) →

6.3 Group Settings

Group systems to keep audio separated.

Typical use cases:

- Multiple systems in same area
- Large venues with different zones
- Shared or rental receivers

Why use this:

- No cross-connection between groups
- No need to pair devices one by one
- Set up all devices at once

Set up via DFU:

- [Speakers](#) ↗
- [Transmitter](#) ↗

Next

6.4 Extend Range

Use **Daisy Chain** to extend coverage.

Typical setup:

2 x Harmony A1 + 1 x [AuraLink](#)

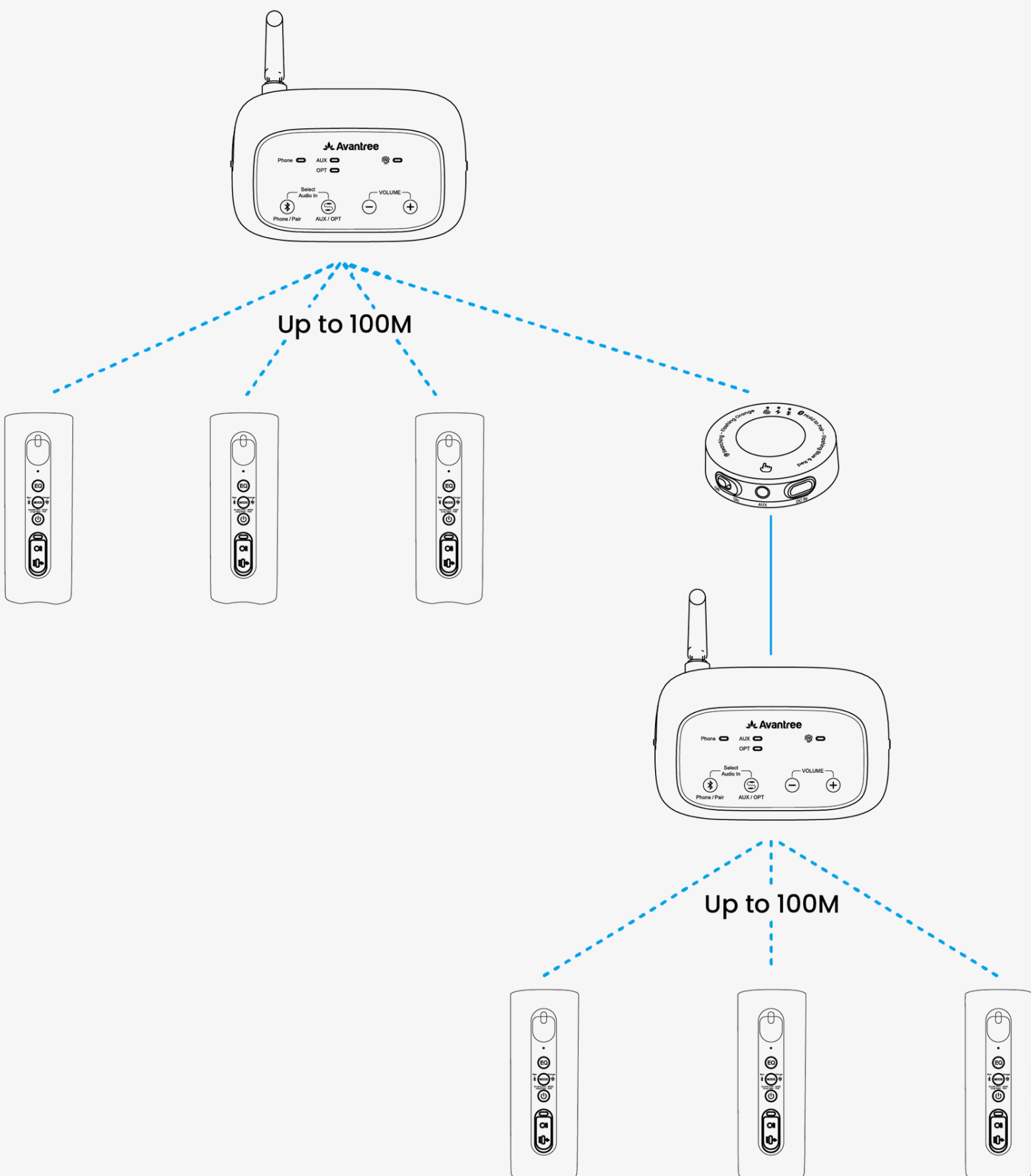

Next

[Rate This Guide](#) →

7. Use as Bluetooth Speaker

- 1 Turn on speaker → Auracast mode.
 - 2 Double-press **MODE** → LED blinks red & blue (Bluetooth pairing).
 - 3 On your device, turn on Bluetooth and select Harmony A1.
- ✓ Connected: LED turns solid blue.

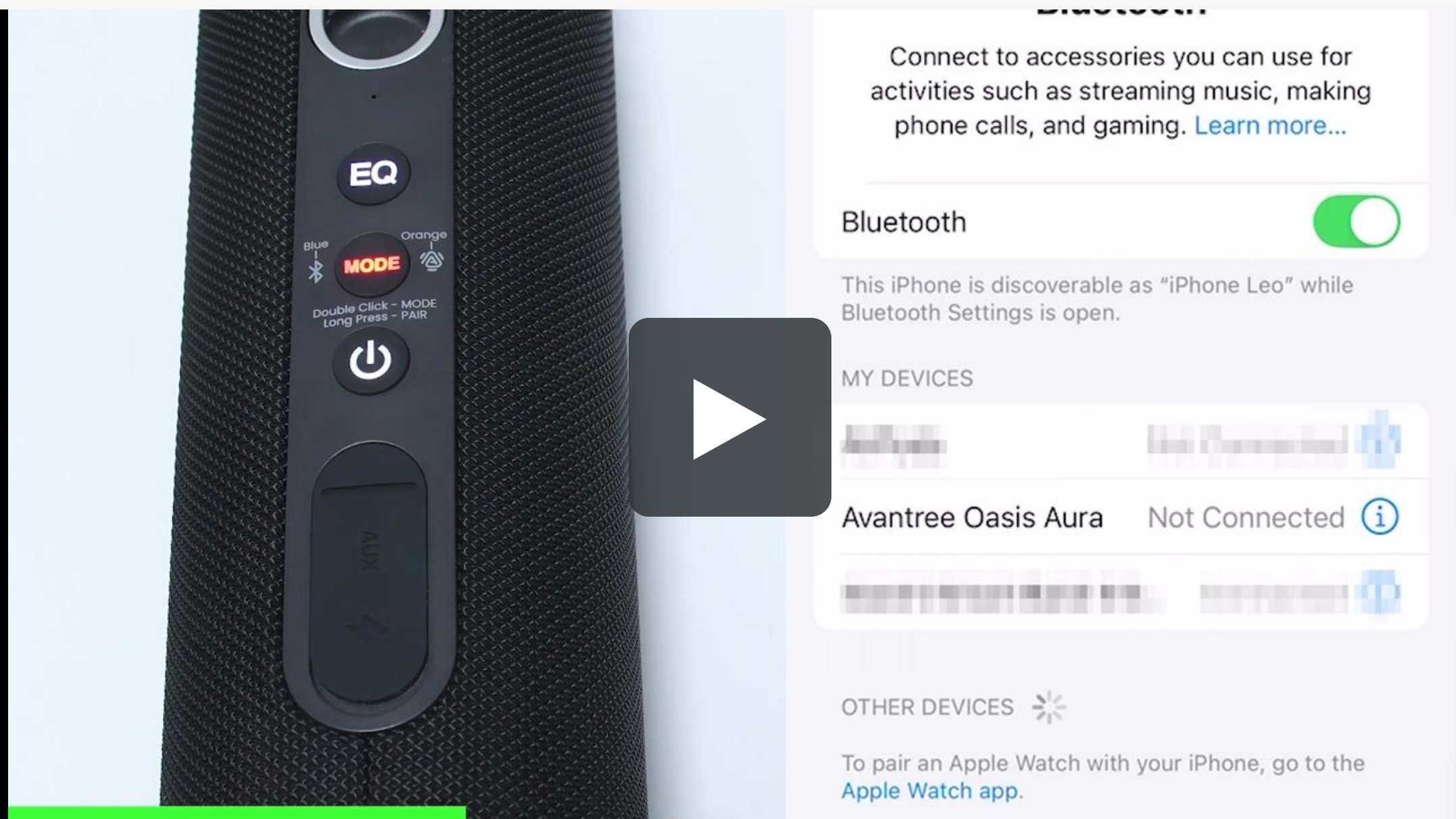

Next

Rate This Guide →

8. Firmware Update

Latest Updates

- Stays ON with no audio when plugged in
- Ambient light OFF by default (hold EQ to toggle)
- Status lights turn off after 30s in standby

Get started

- [Register your product](#)
Get email alerts for new releases
- [Visit our website](#)
Check anytime for the latest version

Next

[Rate This Guide →](#)



9. Troubleshooting

Common Issues

- Keep speaker ON while plugged in
- Audio cuts out with phone
- Audio quality degrades over time

 [More FAQ & Help ↗](#)

 *Still need help?* [Contact support ↗](#)

Next

[Rate This Guide →](#)

< Back

 Menu

10. Support & Feedback

Agent Support

Need help? We're here.

 Email

 Call

 Chat

Register Your Product

Extended warranty & get updates.

[Get 24M Warranty](#)

[Rate This Guide →](#)