



Aria Podio 3

Cuffie con supporto di ricarica



Utente Interattivo Guida

Versione 1.9.1

Avvia configurazione

< Indietro



Menu Principale

1. Prima di Iniziare
2. Pulsanti & Indicatori
3. Come Caricare
4. Configurazione del Dispositivo
 - A. Uso con Telefono
 - B. Uso con PC
5. Configurazione Avanzata
6. Risoluzione dei Problemi & Domande Frequenti
7. Ottieni Aiuto & Aggiornamenti

Avanti



1. Prima di Iniziare

- Ottimo per conversazioni chiare: Dotato di **cancellazione attiva del rumore** e di un microfono a braccio staccabile con cancellazione del rumore.
- **Connettività multipunto:** Connetti a **due** dispositivi contemporaneamente e passa facilmente da uno all'altro.
- Tempo di riproduzione esteso: Goditi fino a **55 ore** di utilizzo con una singola carica.

Avanti

È stato utile?



2. Pulsanti & Indicatori

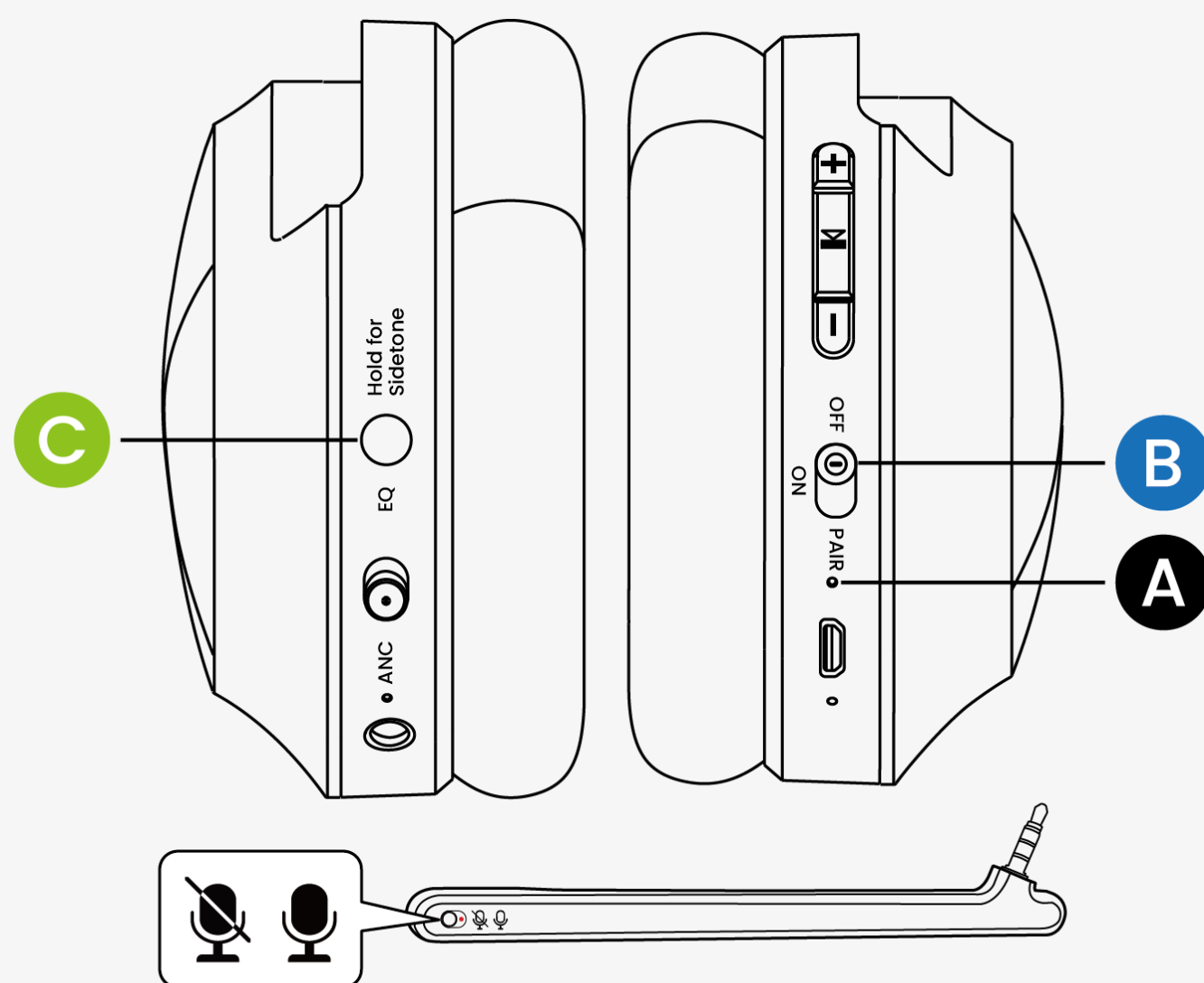

A Indicatore LED

Solido → Connesso

Lampeggiante → Non Connesso

B Interruttore

Tieni premuto per **ABBINA** 3s →

Accoppiamento (**rosso** & **blu** lampeggiano)

C Tono laterale

Tieni premuto **2s** → Attiva/disattiva il
tono laterale (microfono boom richiesto)

[👉 Guida Completa a Pulsanti & Indicatori ↗](#)

Avanti

È stato utile?



3. Come Caricare

- Usa il supporto o il cavo **USB-C** (5V, 1-2.4A).
- Ricarica: la LED rimane **fissa rossa**.
- Carica completa: la LED si spegne (**circa 2h**).
- Tempo di riproduzione: fino a 55 ore.

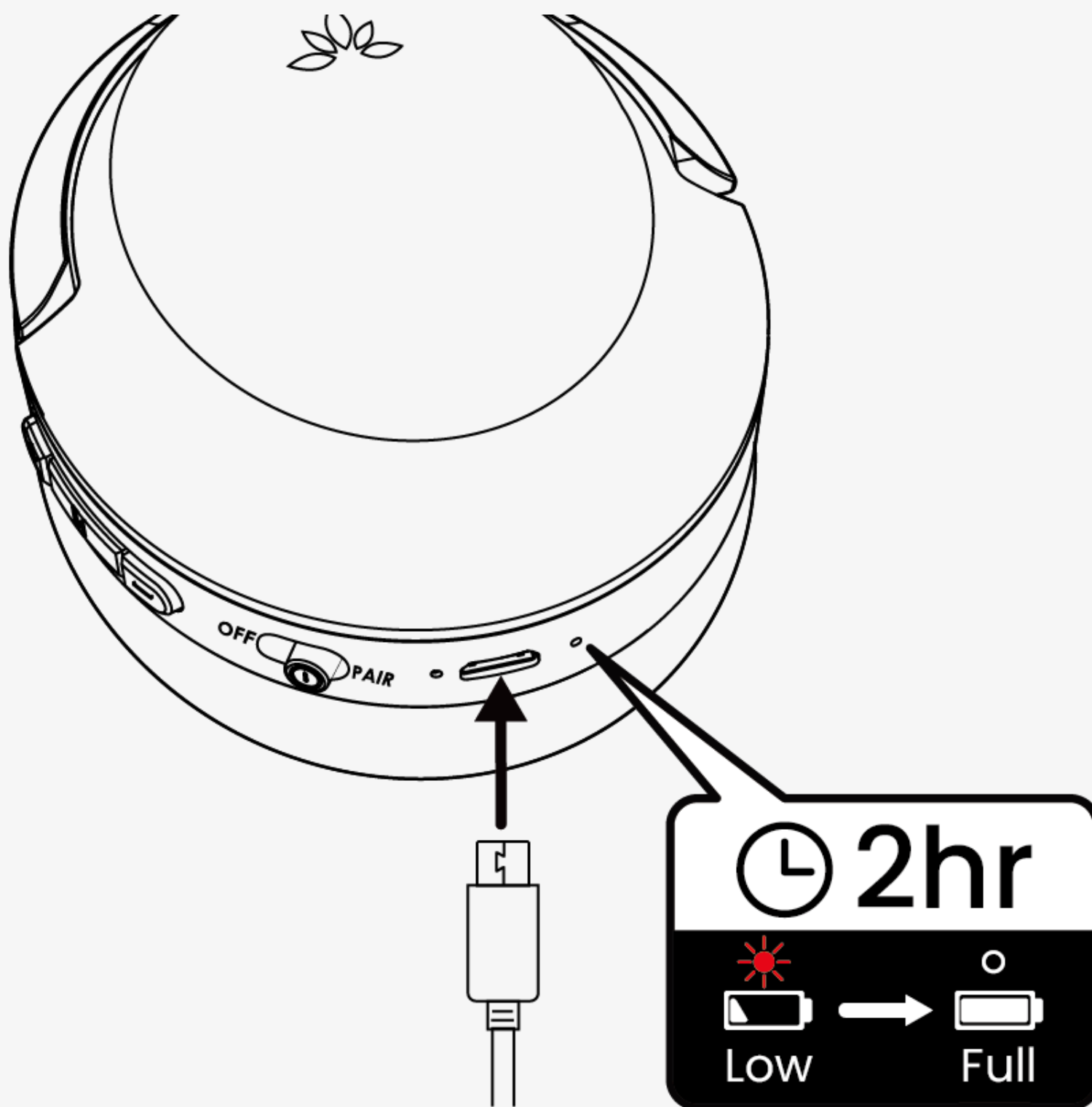

Avanti

È stato utile?



4. Configurazione del dispositivo

Seleziona un'opzione di seguito per continuare:

A

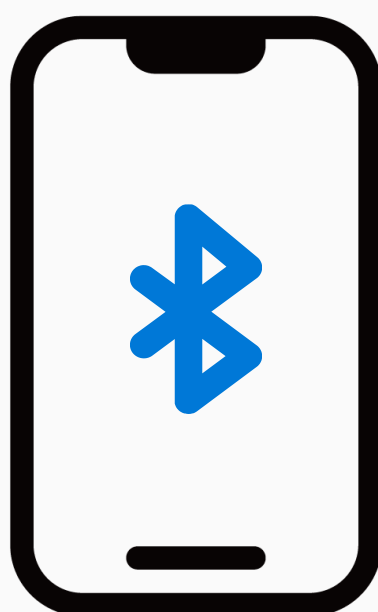

[Telefono](#)

B

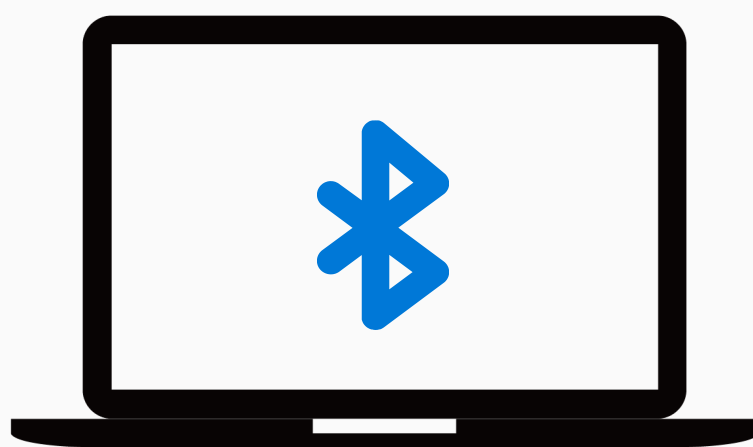

[PC](#)

È stato utile?



A. Usa con telefono

❶ Sul telefono: apri **Impostazioni Bluetooth**

❷ Scorri e tieni premuto per **ABBINA**
LED lampeggia **rosso** e **blu**

Sul telefono seleziona "**Avantalk Aria Podio 3**"

❸ Promemoria vocale "**connesso**"
Riproduci musica normalmente



Avanti

È stato utile?



B. Usare con PC

- 1 Su PC: apri **Impostazioni Bluetooth**
- 2 Scorri e tieni premuto per **ABBINARE**
LED lampeggia **rosso** e **blu**
Sul PC seleziona "**Avantalk Aria Podio 3**"
- 3 LED **solido** = connesso
Riproduci musica, regola il volume



Avanti

È stato utile?





B.2 Seleziona il tuo sistema operativo

Imposta **Avantalk Aria Podio 3** come predefinito ingresso e uscita nelle impostazioni audio.

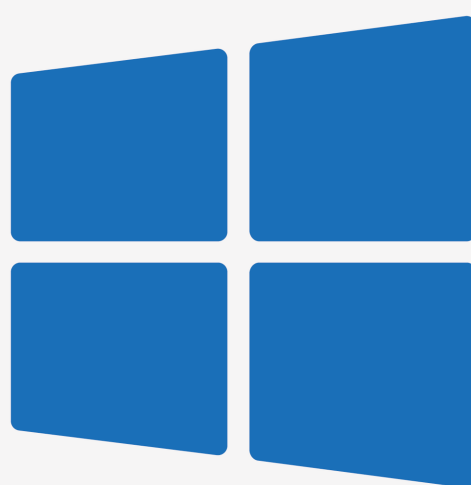

Windows



Mac

È stato utile?



< Indietro



B.2a Impostazioni audio del PC Windows

1 Vai a **Impostazioni** → **Suono**

2 **Uscita**  → "Avantalk Aria Podio 3"

3 **Input**  → "Avantalk Aria Podio 3"

Output

 Choose where to play sound
Apps might have their own settings

Speaker
Avantalk Aria 3
Default device

Speaker
Realtek(R) Audio
Enabled



Pair a new output device

Volume

Avanti

È stato utile?



< Indietro

 Menu

B.2b Impostazioni Suono Mac

- ❶ Vai a **Impostazioni** → **Suono**
- ❷ **Uscita**  → "**Avantalk Aria Podio 3**"
- ❸ **Ingresso**  → "**Avantalk Aria Podio 3**"

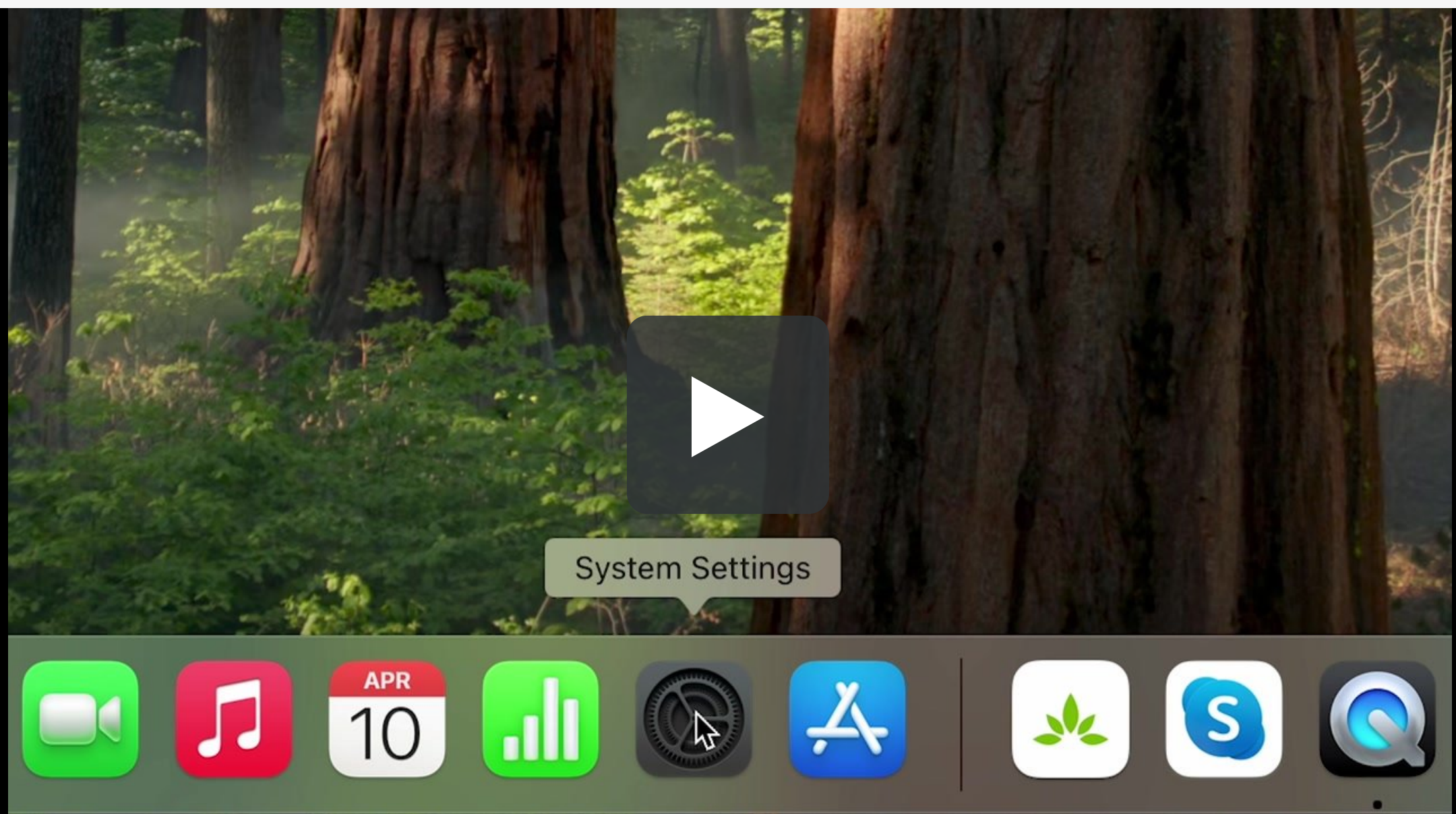

Prossimo

È stato utile?



B.3 Impostazioni Suono

App

Se si utilizza un'app per effettuare chiamate, potrebbe essere necessario configurare anche le impostazioni dell'app.

a



[zoom](#)

b



[Teams](#)

c



[Discord](#)

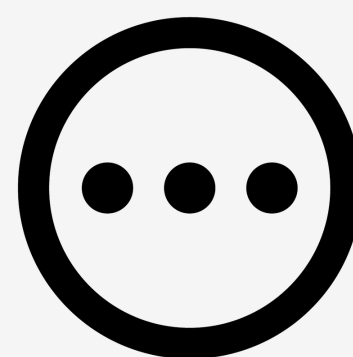

[Altro](#)

È stato utile?



B.3a Impostazioni audio

Zoom

❶ Vai all'app Zoom → Impostazioni → Audio

❷ Altoparlante  → "Aria Podio 3"

❸ Microfono  → "Aria Podio 3"

⚠ Se appaiono "Hands Free" e "Stereo", seleziona Hands Free.

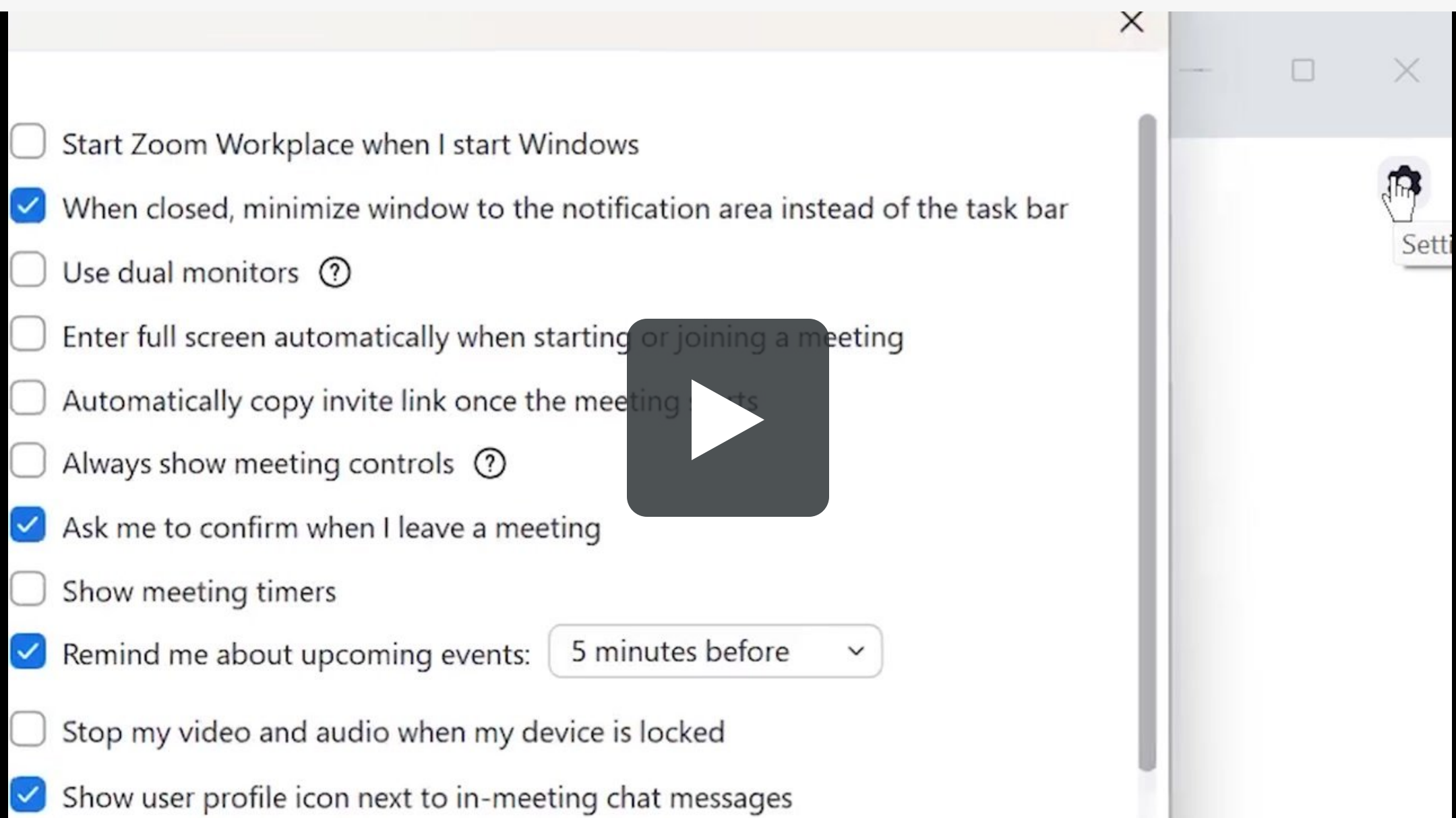

Avanti

È stato utile?



B.3b Impostazioni Suoni Team

1 Vai all'app Teams → Impostazioni → Dispositivi

2 Altoparlante  → **"Aria Podio 3"**

3 Microfono  → **"Aria Podio 3"**

⚠ Se appaiono "Hands Free" e "Stereo", seleziona Hands Free.

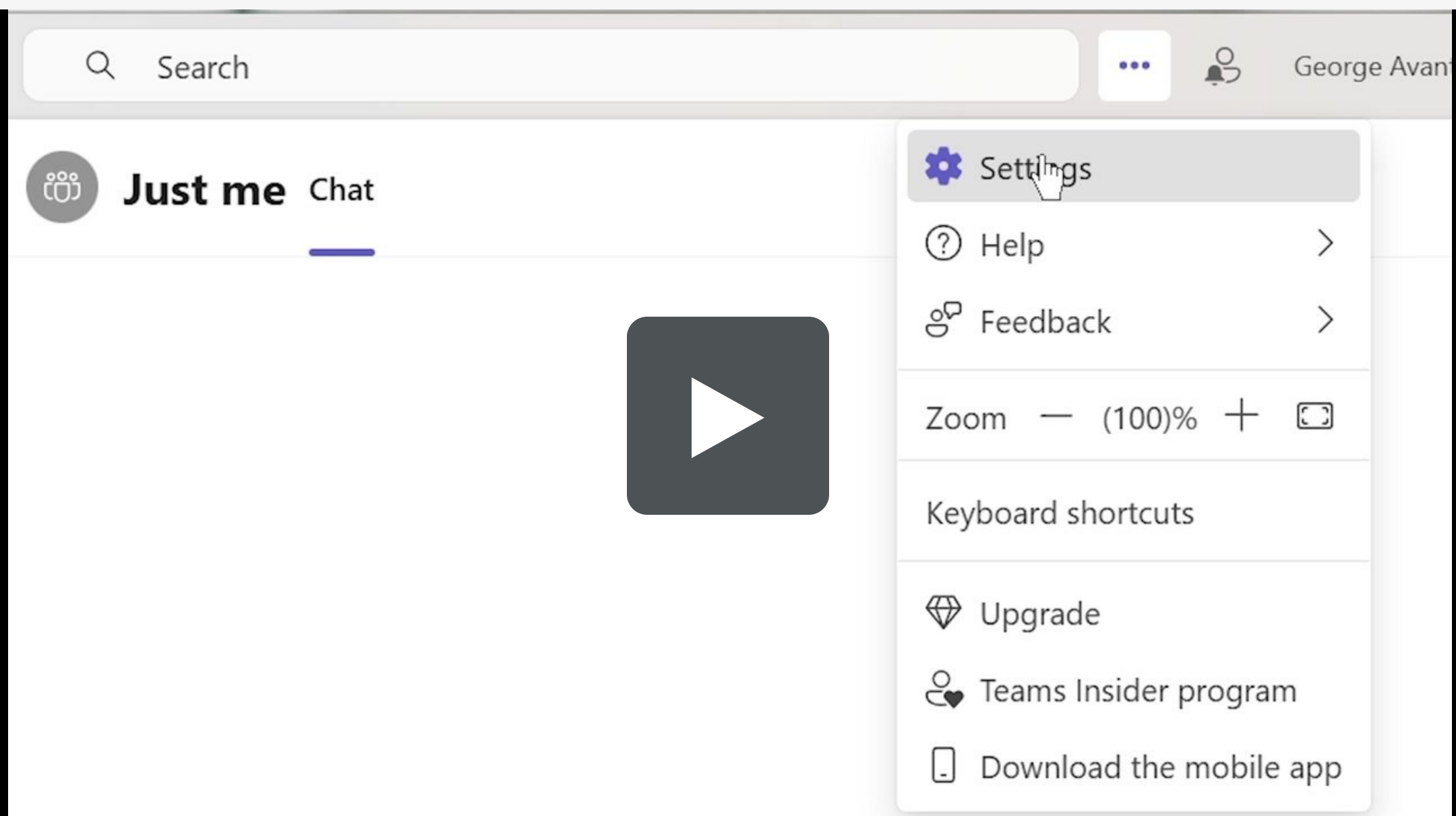

Prossimo

È stato utile?



< Indietro

 Menu

B.3c Impostazioni audio Discord

❶ Vai all'app Discord → Impostazioni
→ Voce e Video

❷ Uscita  → "Aria Podio 3"

❸ Ingresso  → "Aria Podio 3"

⚠ Se appaiono "Hands Free" e "Stereo",
seleziona Hands Free.

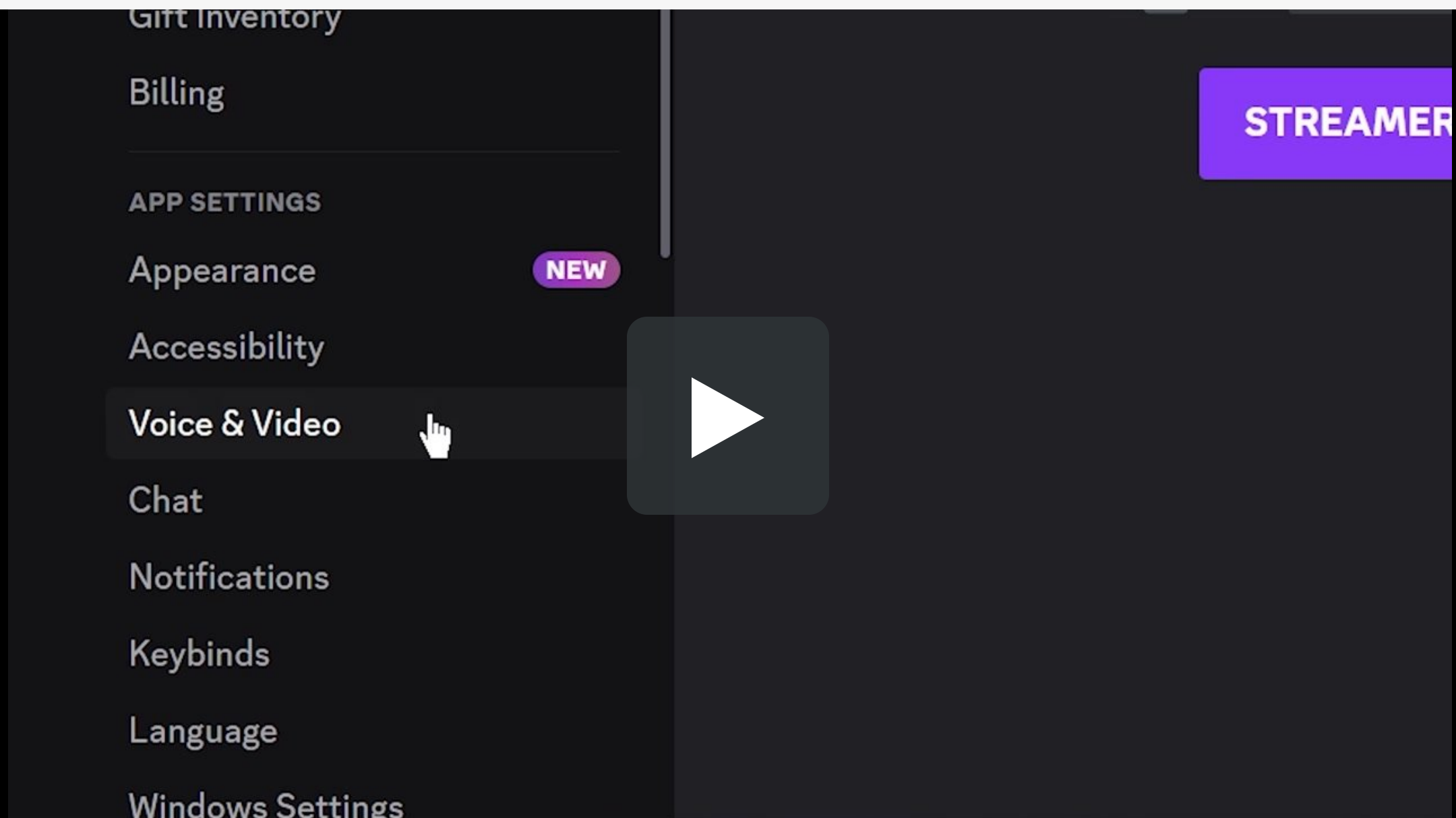

Avanti

È stato utile?



5. Configurazione Avanzata

A. Connetti a Due Dispositivi

Le cuffie supportano **accoppiamento multipunto**. Dopo averle connesse al primo dispositivo, mettile in modalità **Accoppiamento** per connetterti a un secondo dispositivo Bluetooth.

[[Visualizza di più](#) ↗]

Avanti

È stato utile?



B. Microfono a braccio

- 1 Inserisci il microfono a braccio **salda** nella porta.
- 2 Assicurati che l'interruttore di silenzio sia impostato su **OFF**.



Avanti

È stato utile?





6. Risoluzione dei problemi & FAQ

Ecco alcune domande frequenti:

- [Usa con due dispositivi ↗](#)
- [Resetta le cuffie ↗](#)

[👉 Altre FAQ & Risoluzione dei problemi ↗](#)

Avanti

È stato utile?





7. Ottieni Aiuto & Aggiornamenti

1. Registra il tuo prodotto

Estensione della garanzia & ricevi aggiornamenti.

[Registra il tuo prodotto](#)

2. Supporto agenti

Hai bisogno di aiuto? Contatta i nostri agenti.

 [Email](#)  [Chiamata](#)  [Chat](#)

3. Condividi feedback

Il tuo feedback è prezioso.

 [Valuta questa guida](#)